

# watermaker AQUA | TEC

## Technical Manual

for installation, operation and maintenance

Modular DD 500, 12 or 24 Volt



Version 75 - 06.2023  
Download latest manual at:  
<https://www.aquatec-watermaker.de/en/downloads.html>  
or the adjacent QR code  
In case of doubt, the German original manual applies.



AQUATEC- Water maker, Manufacture and distribution by North-Marine Handels GmbH Papenreye 61, D 22453 Hamburg.	
Contact	sup@aquatec-watermaker.de, Tel: +49 (0)40-36850306
Web	www.aquatec-watermaker.de

All contents of this manual, in particular texts, photographs and graphics are subject to German copyright law. Copyright held by North Marine Handels GmbH. Duplication, editing, distribution and any kind of use outside the limits of copyright law require the written approval of the author.

**Thank you** to choose an AQUATEC Watermaker for the provisioning of fresh water on your boat. AQUATEC equipment is made from high-quality components exclusively and has proven its reliability on long cruising-yachts. We are convinced that our product will serve you for many years without interferences.

**Recommendation for using your Aquatec reverse osmosis system.**

Daily use is preferable to a one-time weekly use.

The system produces water with a neutral taste and very good quality.

**Important:** The drinking water must be bottled from the test outlet of the system during operation, ideally after filling the on-board water tank. Only fill the required amount until the next operation of the plant. Clean the drinking water bottle regularly.

If the product water from the on-board water tank is used as drinking water, follow-up-treatment is recommended. No further treatment is usually necessary as service water.

**Scope of delivery Seawater R.O. AQUATEC DD 500:**

- Pump head duplex stainless steel 1.4462
- Pressure regulation-valve duplex stainless steel 1.4462
- Stainless-steel High-pressure gauge
- Stainless-steel Low-pressure gauge for feed flow
- Efficient feed pump
- Control panel cpl. mounted
- 2 pieces stainless-steel high-pressure fittings for self- assembly
- Detailed manual in German or English
- 10-liter tank for preservation and cleaning



Connection cable, through-hull fittings and sea cock must be provided on-board.  
See last page for complete part list.

**Option:** Cruising kit DD 500



- 4 filter-cartridges 5 Micron, 2 filter- cartridges charcoal.
  - Detergents: Acid, Alkaline, Biocide (500, 400, 600 Gr.) for preservation and cleaning.
  - 1 set low- and high-pressure gasket for hp pump,
  - 1 set of hp pump valves (6 pc.).
  - O-ring spare part kit for hp pump and membrane.
- This option eliminates the smaller amount of biocides included in the standard delivery.

This instruction includes important safety information and instructions for commissioning, operation and maintenance of the Aquatec Watermaker components. It is essential therefore, that the responsible specialist refers to it before starting any work on the machinery as well as prior to commissioning. Furthermore, this instruction must always be available on site.







To ensure total satisfaction, please read this user manual carefully. Warranty will be void if the installation does not meet this requirement. Disregarding the warnings / instructions in the User Guide and incorrect installation can lead to serious health damage or possibly the loss of the vessel.

The following symbols and their meaning must be observed throughout the manual. Please follow the instructions and take appropriate measures.

### EXPLANATION OF SYMBOLS

	<p><b><u>Warning!</u></b> Immediate danger that can lead to serious injury to persons or damage to the machine or the loss of the vessel.</p>		<p><b><u>Warning!</u></b> Warnings regarding electric power equipment. Non-observance of safety instructions could lead to danger of life or limb:</p>		<p><b><u>Attention!</u></b> Indicates an instruction that requires special attention.</p>
---	---	---	--	---	---

### Please note the following information.

 <p><b><u>Warning!</u></b></p>	<p>Damage to pumps and system parts due to dry running or insufficient water supply are not covered by warranty.</p>
 <p><b><u>Warning!</u></b></p>	<p>Aquatec Watermaker are designed for permanent installation on ships. Operation of the system is only permitted with clean seawater.</p>
 <p><b><u>Warning!</u></b></p>	<p>Never operate your Aquatec Watermaker unsupervised and leave the operation only to trained persons. Please note: If there are any leaks, the boat can fill up with water and sink, thereby endangering the life of the people on board.</p>
 <p><b><u>Warning!</u></b></p>	<p>Install the high-pressure pump on a stable substrate. Install the high-pressure pump in a dry area which allows an exchange of air necessary for cooling the motor-pump unit. The pumps may not be operated if explosive or flammable Materials are present. Please note: The motors and pumps develop high temperatures during operation. Touching it can cause burns.</p>
 <p><b><u>Warning!</u></b></p>	<p>The installation of the hoses to the components of the system must be carried out in compliance with the bending radii without stress and vibration (risk of breakage).</p>
 <p><b><u>Attention!</u></b></p>	<p>Like any piece of mechanical equipment, the system will require inspection and service from time to time. For easy access to enable a simple regular monitoring and proper maintenance do not place the components in inaccessible areas. It should be easily accessible roundly to make service and inspection work as comfortable as possible.</p>
 <p><b><u>Attention!</u></b></p>	<p>The already assembled membranes can be stored for approx. 5 months in the sealed pressure tube, preferably cool, but preferably not above 20 ° ambient temperature. However, we recommend installing and using the Watermaker as soon as possible.</p>

## Table of contents

### Notes / Info

2	Scope of delivery
3	Safety warnings
5	Introduction reverse osmosis

### Operating

6 - 7	Start plant
8 - 9	Shutdown, fresh water flush.
10 - 11	Long term preservation (mothballing), antifreeze
12 - 13	Membrane cleaning

### Installation

14	Installation / Flow diagram
14 - 19	Installation / plant
20	Installation / Electrical connection
21	Blank page

### Important

22	Inspection - maintenance - oil change
----	---------------------------------------

### Technic

23	Change of membranes
24 – 25	Troubleshooting
26 – 27	Exploring diagram high-pressure-pump
28	Pressure regulation valve / HP-pump-motor
29 - 30	Hose dimensions / Specification
31	Part List

## Introduction

### The principle of reverse osmosis (RO)

In natural sciences and technology, osmosis is perceived as the directed migration of molecules through a semi permeable membrane. The chemical and physical structure of the membrane determines which molecules are able to pass and which are not. For this reason, it is called semi-permeable, which means as much as halfway or partial permeability.

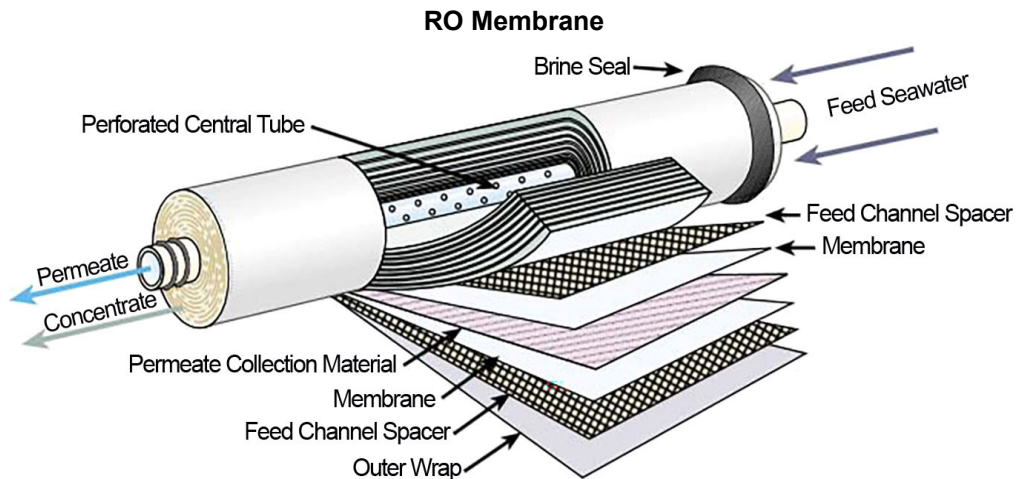

If one mixes different liquids, like in this case water with different salinities, they aim to equalize their concentration. That way, the seawater would be thinned out and the drinking water would be enriched with salts. The effect would be a less concentrated, homogeneous dissolution. Pouring sea- and fresh water in equal amounts into a container where both liquids are separated by an adequate semi-permeable membrane, there would be one side with seawater that is highly loaded with salts, on the other side more or less "clean" water without or with little dissolved components.



The natural tendency of both liquids to equalize their salinity leads to the migration of water molecules from the fresh water side towards the seawater side. As a result, the volume of water on the fresh water side decreases while it increases on the seawater side. This process of osmosis takes place until the pressure on the seawater side is in accordance with the osmotic pressure. Then it stops. In this case, the osmotic pressure is around 30 bar.

The described process however is reversible by exposing the liquid on the seawater side to mechanical pressure. At a pressure of 30 bar, the osmotic process cannot take place or would rather be reversed. When pressure is increased beyond 30 bar, for instance 60 bar, water molecules from the seawater side migrate to the fresh water side. All other components of the seawater dissolution are not able to pass the membrane. As a result, the dissolution on the seawater side remains highly-concentrated while there is a gain of fresh water on the other side of the membrane. This process is referred to as reverse osmosis (R.O.)



The seawater is delivered to the pressure pipe's entry side of a RO-system by a high-pressure pump. The osmotic membrane is located in the pressure pipe and is merely permeable for the vehicle "water" (solvent) and detain the solute substances. When the pressure difference is more than leveling out the osmotic head, the water molecules are able to pass the membrane that works like a filter, while the "unpurified" molecules are detained. In opposite to a classic membrane-filter, osmosis membranes do not have continuous pores. In fact, the ions and molecules are migrating through the membrane by diffusing through the membrane material.



Inside of the membrane, the permeate-tube is located which transports the product-water (permeate) through one of the two end caps of the pressure pipe towards the fresh water tank. The excess seawater, now referred to as concentrate (brine), is drained off overboard through the outlet of the pressure pipe by a pressure control valve.

### Operating instructions

 <b>Warning!</b>	Never operate your Aquatec Watermaker unsupervised and leave the operation only to trained persons. Please note: If there are any leaks, the boat can fill up with water and sink, thereby endangering the life of the people on board.
 <b>Attention!</b>	Do not operate your water maker with unpurified seawater (oil, chlorine or other chemicals).
 <b>Warning!</b>	The R.O. membranes are conserved with a dissolution that, when ingested, can cause irritations of the gastrointestinal tract. For that reason, the product water must not be consumed within the first 30 minutes of operating time, beforehand it has to be drained over the test-outlet. This applies accordingly after temporary shutdown or cleaning of the membranes with the cleaning chemicals.

### Placing into operation

 <b>Attention!</b>	Avoid starting the HP-pump several times in short intervals or starting with closed pressure control valve to avoid a defect of the motor capacitors.
 <b>Attention!</b>	<b>Important:</b> Check the oil level and condition of the high-pressure pump oil daily. In the event of condensation in the oil (whitish/greyish discoloration due to continuous operation, warm environment), change the oil immediately.

	<p>1) Open the seawater intake valve (no.10).</p> <p>2) The pressure control valve (no.5) in the control panel has to be fully opened by turning counter clockwise.</p> <p> <b>Warning!</b> Never start your Aquatec with closed pressure control valve!</p> <p>Starting with a closed valve destroys the pressure reading and possibly essential parts of the equipment.</p> <p>An open pressure control valve can be seen when the first two threads of the valve body becoming visible by turning the pressure control wheel. (see picture left)</p>
<p>3) Turn three-way valve (no. 4) according to the flow diagram to position fresh water production. Turn three-way valve (no. 2) to position test-outlet.</p> <p>4) Switch on the feed pump. The gauge (no.9, "pressure feed water") must show positive pressure. De-aerate the pre-filter system if necessary and control the drain water. To prefill the system, a short fresh water flush via the onboard pressure water pump can be useful.</p> <p>5) Switch on the high-pressure pump.</p> <p>6) Increase the pressure at the pressure control valve (no.5) by slowly turning it clockwise to about 30 bars. Let the system work for about 30 seconds. There should not be any air pockets visible in the system.</p> <p>7) Increase the pressure stepwise up to the <b>maximum working pressure (55 bar, 800 psi)</b>. Test the product water by tasting from the test outlet (at daily operation, the product water should be salt-free after about 60 seconds). By shifting the three-way valve no. 2, the product water is fed into the fresh water tank.</p> <p>8) <b>Important:</b> During operation, check the entire system for leaks and smooth running. Operation is not permitted if the system is in a faulty condition.</p>	

 <b>Warning!</b>	Never turn the pressure regulation knob completely out while the system is running. The pressure pushes out the parts inside, which can result in injury and loss.
---	--

 <b>Attention!</b>	The maximum working pressure of <b>55 bar (800 psi)</b> must not be exceeded. If the system is operated in brackish water, seawater with lower salinity or higher water temperature is operated, the fresh water production must not exceed the value specified for the plant! In this case, adjust the working pressure under constant observation of the product water quantity only up to the standard quantity of water production. (e.g. Baltic Sea about <b>35 bar or 490 psi</b> )
---	---



**Flow diagram water production.**

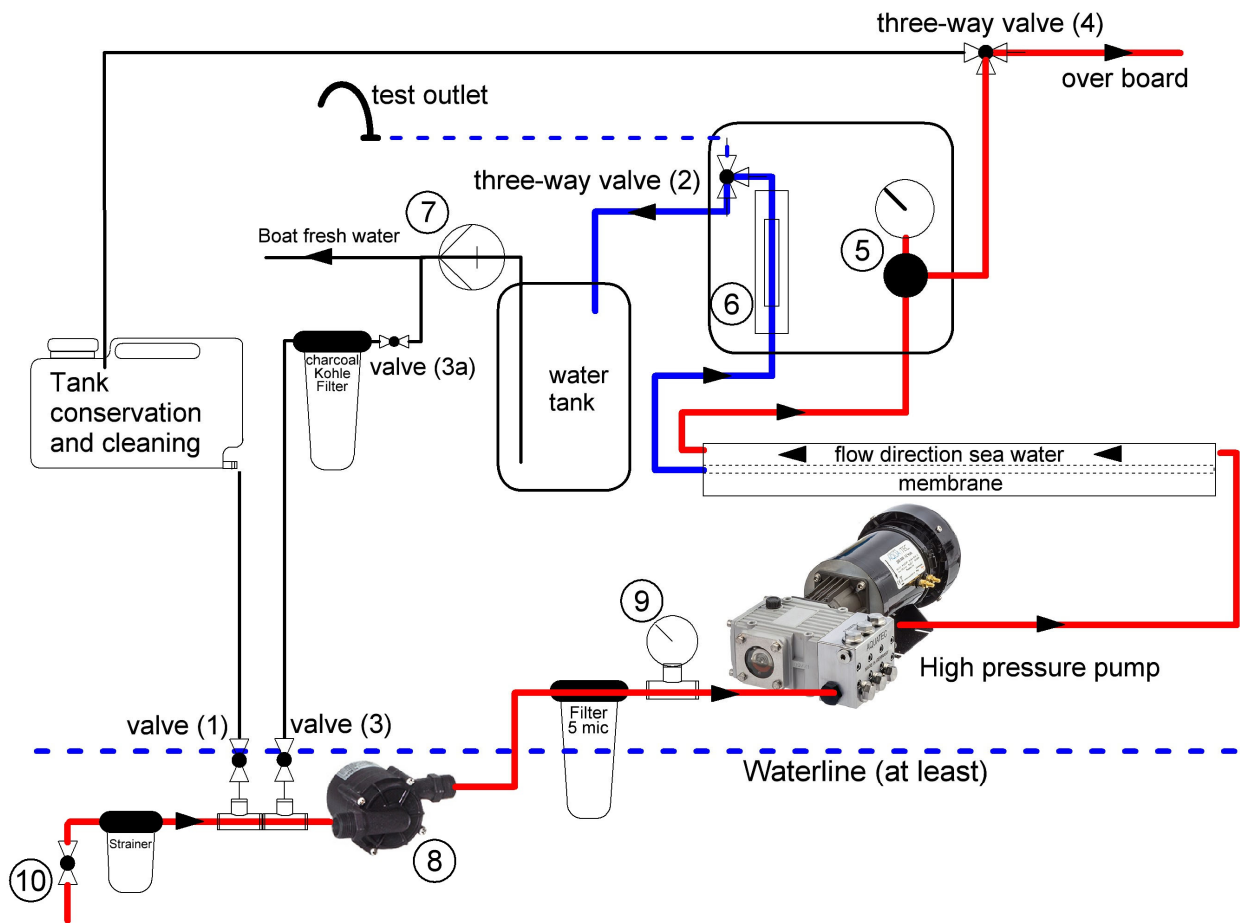

(5) Pressure regulation valve	(6) Flowmeter product water
(7) ships fresh water pump	(8) Feed pump
(9) Gauge feed pressure	(10) Seacock

 <p><b>Note!</b></p>	<p>The drinking water production changes according to the salinity, the temperature of the seawater and the age of the R.O. membrane. The data regarding the fresh water production apply to a salinity of 35 grams/ litre at a temperature of 25° Celsius (77° Fahrenheit) at the new membrane. A discrepancy up to +/- 10% also in the power consumption, especially in the first 50 hours of operation, are usual.</p> <p>At a sea water temperature below 25°C the product water quantity will be reduced as follows: e.g. water temperature 15°C, approx. minus 20% / water temperature 5° C, approx. minus 35%.</p>
---	---

### Switch off the system, fresh water flush

- 1) Open the pressure control valve until the plant runs without pressure.
- 2) Run the Aquatec several minutes to remove the concentrated salt from the membranes.
- 3) Turn three-way valve (no. 2) to position test-outlet.
- 4) Switch off the high-pressure pump first and then the feed pump.
- 5) Close the sea water intake valve.
- 6) Open valve (no. 3). The fresh water pressure pump of the boat should turn on now flush the system.  
Duration of flushing time see "flushing time".
- 7) Close valve (no. 3) to finish the fresh water flush.

### Description fresh water flush

The fresh water rinse is activated by opening valve (no.3). For this, the seacock must be closed. When that valve is open, fresh water could drain to the sea.

At least 10-15 liters of fresh water is required per membrane A charcoal filter removes any existing chlorine inside the fresh water tank which destroys the membrane.

 <b>Attention!</b>	The carbon filter ensures a chlorine separation up to 4 litres/minute. If necessary, the performance of the on-board pressurized water system must be reduced to avoid damaging the membranes by prevent chlorine. This note only applies when chlorine is used in the drinking water tank. Membrane and HP pump reduce the flushing rate by their internal resistance.
---	--

#### Flushing time:

The time needed for the fresh water rinse depends on the board-side performance of the fresh water pump and the condition of the membranes and therefore cannot be stated on factory side.

Please find out the required amount of flushing water by discharging the rinsing water into a bucket once after a normal operation (take off the hose at the thru-hull fitting) and check the salinity constantly by tasting. During the process, stop the time to find out the time requirement of future flushes. By collecting it in a bucket, you also find out the needed amount of flushing water.

#### Hint:

If there is no chlorine present in the fresh water tank, running the feed pump and HP-pump can accelerate the fresh water flushing. Thanks to the well-known pump performance of the HP-pump, the necessary flushing time can be precisely adjusted. Note: the onboard fresh water pump must provide sufficient flow. Performance flow DD 500 ca. 3,3 litre/ minute.

 <b>Attention!</b>	Fresh water flushing of the Aquatec is recommended after each operation. It reduced biological growth in the membrane and preserves the life span and the reliability of the entire system. After each operation, the Aquatec should be rinsed with fresh water. After fresh water flushing, the system may remain unused for 7-14 days. This process can be repeated as desired to avoid the use of chemicals.
--	--

 <b>Attention!</b>	Prior to a longer period of shutdown (without flushing), the Aquatec has to be preserved with the chemical no. 3 (Biocide). For instructions, see "Long term preservation (mothballing) of the plant".
--	--



## Flow diagram fresh water flush

 <p><b>Note!</b></p>	<p><b>HP- Pump always pressureless!!! (Pressure control valve (5) open).</b></p> <p>The only application with working pressure is the production of product water.</p>
---	--

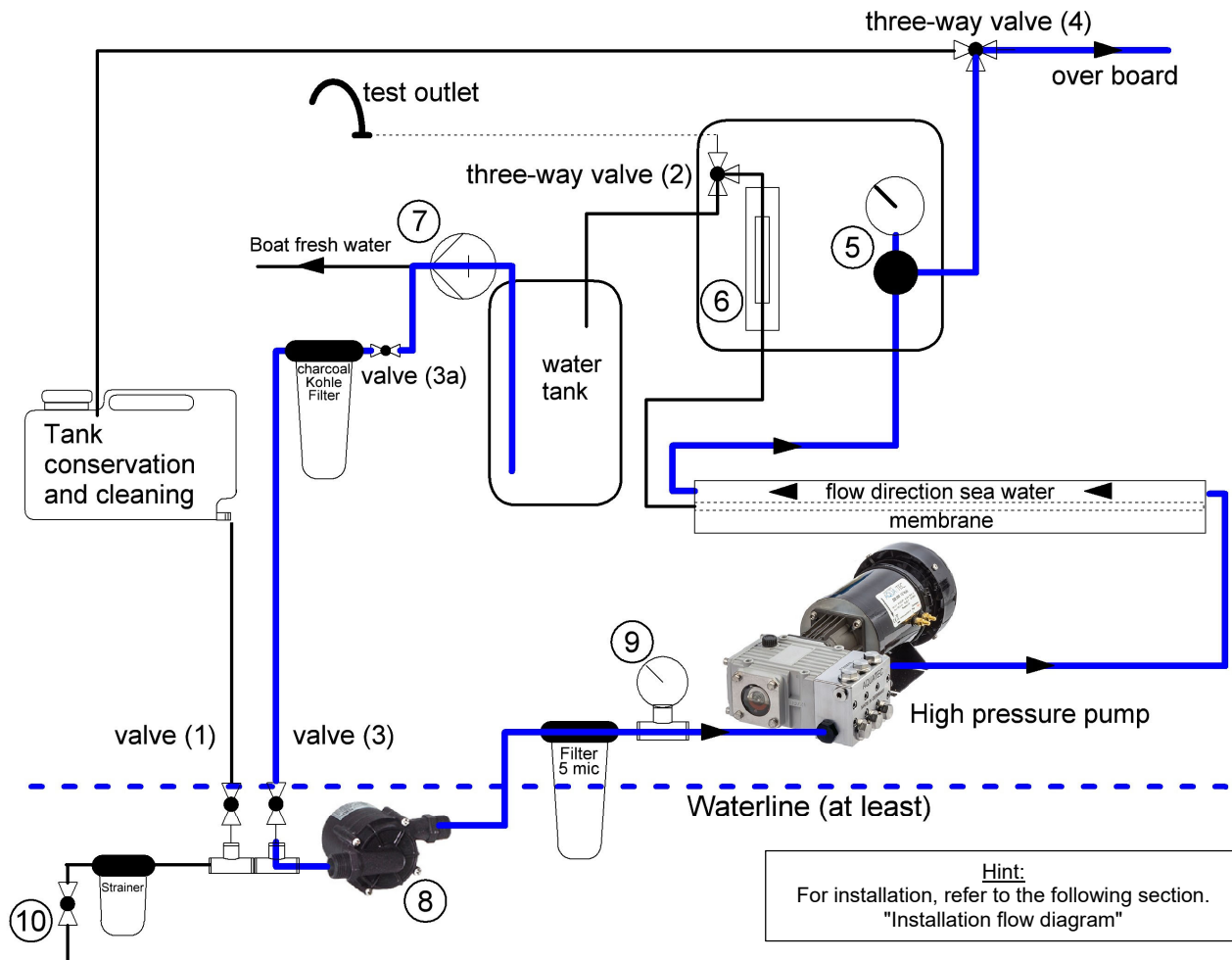



**Hint:**  
 For installation, refer to the following section.  
 "Installation flow diagram"

(5) Pressure regulation valve	(6) Flowmeter product water
(7) ships fresh water pump	(8) Feed pump
(9) Gauge feed pressure	(10) Seacock



## Long term preservation (mothballing) of the plant (Page 1 of 2)

### Description:

Prior to a longer period of shutdown, the Aquatec has to be preserved with chemical no. 3 (Biocide). After mothballing, the plant can be shut down for 6 months, depending on the environmental conditions.

 <b>Attention!</b>	Before preservation and longer downtime. The oil of the high-pressure pump must be changed in order to remove any possibly existing condensation water from the oil. This prevents corrosion of the bearings and surface of the crankshaft
 <b>Warning!</b>	The conservation chemical no. 3 is a Biocide. Please consider the hazard notes on the canisters. Working with chemicals, please wear protective glasses, breathing protection and rubber gloves for your own safety.
 <b>Note!</b>	If there any risk of frost, the entire pressure pipe with internal membrane in the pipe should be dismantled (after preservation) and be stored frost-proof with closed hose connections. The liquid present in the pressure pipe can be drained. Can the membrane not be removed alternatively 20%- 50% glycerin in food quality can be added as an antifreeze to the biocide at preservation (glycol is <b>not</b> permitted as antifreeze). The plant has to be drained (filter housings, pumps, hoses). Remove filter cartridges.

### Instruction for mothballing.

 <b>Warning!</b>	Make sure that you follow the following instructions carefully so that no cleaning chemical gets into your fresh water tank.
 <b>Note!</b>	<b>HP- Pump always pressureless!!!</b> (Pressure control valve (5) open). The only application with working pressure is the production of product water.

<ol style="list-style-type: none"><li>1) Close the sea water intake valve.</li><li>2) The pressure control valve must be open. Turn the product water three-way valve (no. 2) to position <b>test-outlet</b> to avoid that chemicals get into the drinking water tank.</li><li>3) Rinse the system with fresh water as described in "Fresh water flushing".</li><li>4) Turn the three-way valve (no. 4) according to the flow diagram "Long term preservation (mothballing) of the plant". Open valve (no.1).</li><li>5) Dissolve the stated amount of biocide (no. 3) completely in 10 litres of water and pour it into the tank for conservation. (To avoid negative pressure, do not close the cap tightly) As a result of the water already in the system, (each pre-filter= 1 litre, each membrane= 1.5 litres) together with these 10 litres, the result will now be the <b>maximum permitted concentration of 0.5%</b> by weight. A level teaspoon corresponds to 5 grams Biocide (Natriummetabisulfit).</li><li>6) Switch on the feed pump and the high-pressure pump. Let the Biocide circulate through the system for about 2-3 minutes. Perform possibly exiting the test outlet liquid back into the preservative tank.</li><li>7) The Biocide in the tank can be discharged overboard after turning the three-way valve (no. 4). It should be noted that the system gets no air. Switch pumps off.</li></ol>	
---	--

Amount of biocide DD 500	max. 37 gr. Biocide
--------------------------	---------------------

 <b>Note!</b>	For preservation times of approx. 2 months, half of the chemical is sufficient.
--	---

**Long term preservation (mothballing) of the plant. (Page 2 of 2)**

**Hint:**

In order to avoid possible deposits in the pumps, it is advantageous after preserving the membranes to remove the high-pressure hose at the outlet of the HP pump and to wash out the system with fresh water again, this time **without** the connected membrane.

A standard 1/2" hose can be used for this purpose, which should be fitted onto the HP threaded connector of the high-pressure pump to drain the water out into a bucket. Then drain the all the water from the pump, which is important if there is a risk of frost, if possible it is also preferable to blow pressurized air through it in the direction of flow, for this purpose remove the sea water intake hose from the HP pump.

Leakage of the preservative liquid from the pressure pipes is harmless. It is important that membranes with the preservative liquid are well moistened and cannot dry out.

 <b>Warning!</b>	At every recommissioning after cleaning or mothballing, divert the product water over the test-outlet for the first 30 minutes to rinse the chemical completely out of the system.
---	--

**Flow diagram long term preservation (mothballing)**

 <b>Note!</b>	<b>HP- Pump always pressureless!!!</b> (Pressure control valve (5) open). The only application with working pressure is the production of product water.
--	---

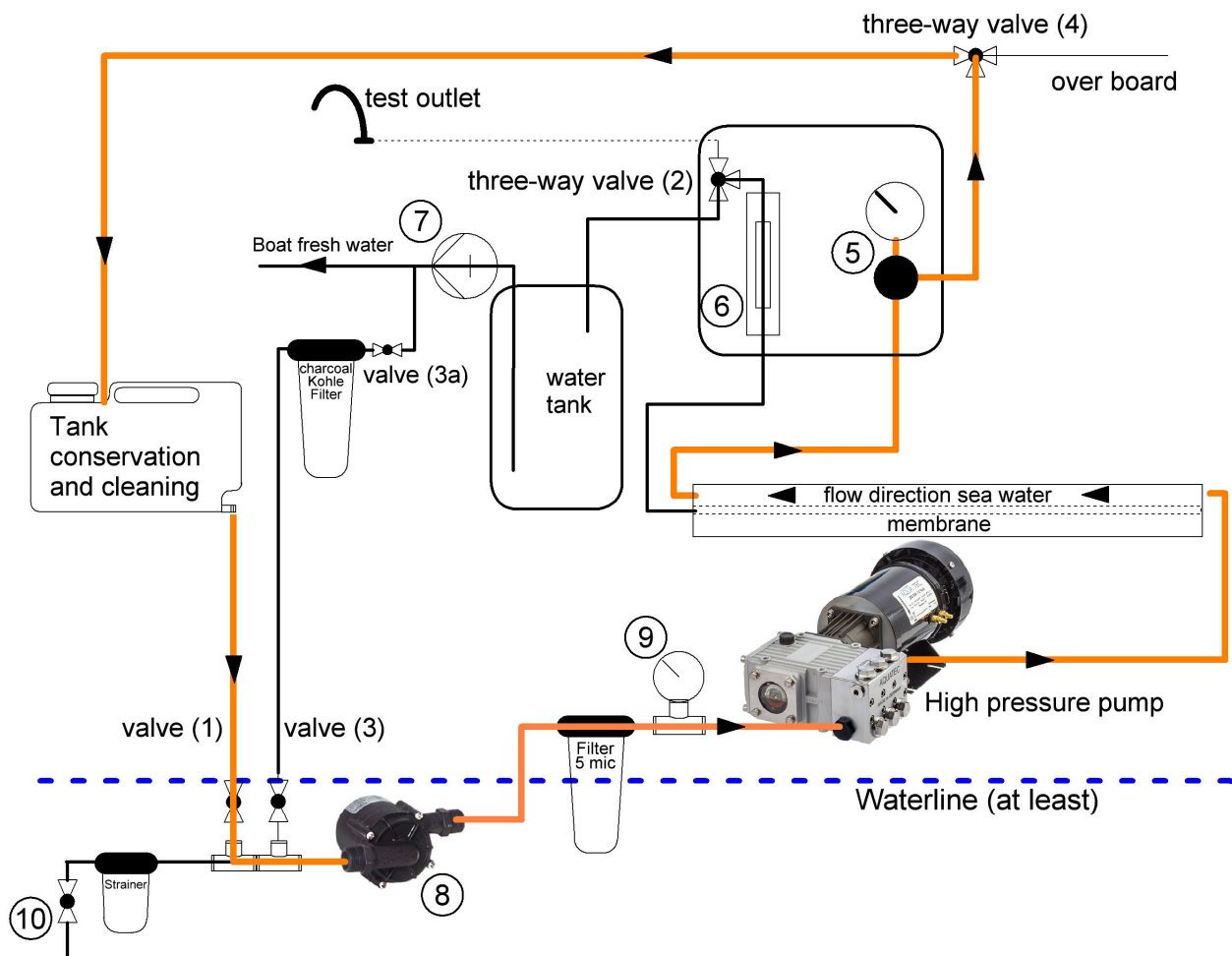

## Membrane cleaning.

### Description:

If fresh water production decreases by more than 15 to 20%, the membrane should be chemically cleaned. High TDS values (water tastes salty) cannot be reduced by cleaning. Here only a replacement of the membrane helps.

 <b>Warning!</b>	Cleaning chemical no. 1 is alkaline and cleaning chemical no. 2 is an acid. Please consider the hazard notes on the canisters. Working with chemicals, please wear protective glasses, breathing protection and rubber gloves for your own safety. Do not mix different chemicals.
---	--

### Instruction for cleaning of membranes.

 <b>Warning!</b>	Make sure that you follow the following instructions carefully so that no cleaning chemical gets into your fresh water tank.
---	--

 <b>Note!</b>	<b><u>HP- Pump always pressureless!!! (Pressure control valve (5) open).</u></b> The only application with working pressure is the production of product water.
--	--

<ol style="list-style-type: none"><li>1) Close the sea water intake valve.</li><li>2) The pressure control valve must be open. Turn the product water three-way valve (no. 2) to position <b>test-outlet</b> to avoid that chemicals get into the drinking water tank.</li><li>3) Rinse the system with fresh water as described in "Fresh water flushing".</li><li>4) Turn the three-way valve (no. 4) according to the flow diagram "Long term preservation (mothballing) of the plant". Open valve (no.1).</li><li>5) Blend about 10 liters warm chlorine-free fresh water, temperature app. 25° Celsius (77° Fahrenheit), with chemical no. 1 (Alkaline), according to the instructions on the package and pour it into the tank for conservation. (To avoid negative pressure, do not close the cap tightly) Since there are about 1,5 litre of water already in each membrane and 1 litre of water in each filter, please add the according amount of chemical to the water that has to be blended in every membrane and filter.</li><li>6) Switch on the feed pump and the high-pressure pump. The unit is run for about 5 minutes to circulate the solution through the membrane. Temperature of the solution must not exceed more than 45° Celsius. Then allowed to rest for an hour, and then run again for 5 minutes. Perform possibly exiting the test outlet liquid back into the preservative tank.</li><li>7) The chemical in the tank can be discharged overboard after turning the three-way valve (no. 4). It should be noted that the system gets no air. Switch pumps off.</li><li>8) After this, the system is put back into service, unpressurized, and run for 15 minutes or so to clear out the cleaning solution, before being returned to regular service. Once again, the initial product water will need to be discharged for 30 minutes over the test outlet.</li><li>9) If there is no change in freshwater output, repeat the procedure 1 to 7 with chemical no. 2 (Acid).</li></ol>	
---	--

 <b>Attention!</b>	Prior to a longer period of shutdown, the Aquatec has to be preserved with Biocide after cleaning and flushing.
---	---

 <b>Warning!</b>	At every recommissioning after cleaning or mothballing, divert the product water over the test-outlet for the first 30 minutes to rinse the chemical completely out of the system.
---	--

## Flow diagram cleaning

 <p><b>Note!</b></p>	<p><b><u>HP- Pump always pressureless!!!</u></b> (Pressure control valve (5) open).                  The only application with working pressure is the production of product water.</p>
---	---

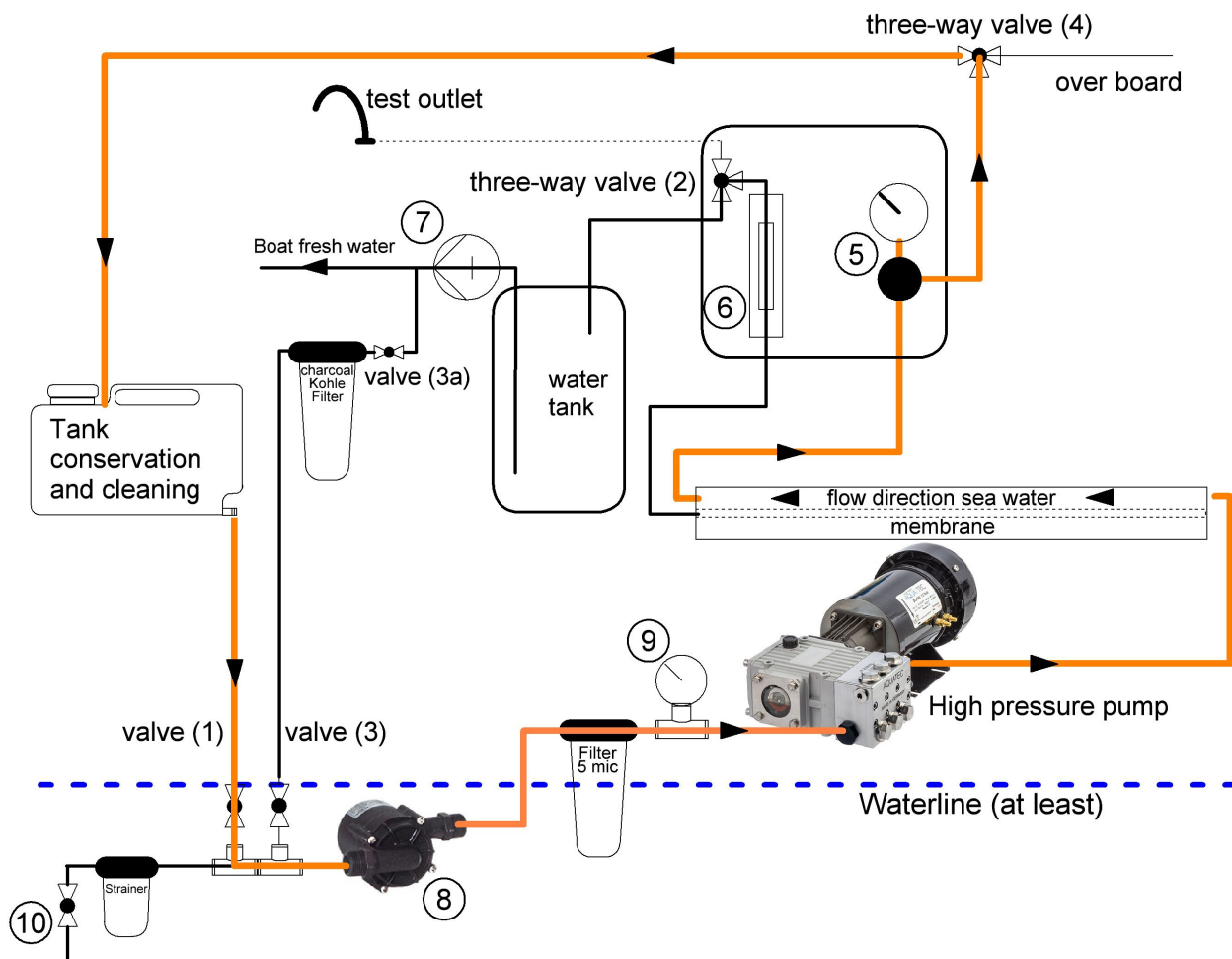



## Installation guide page 1

 <b>Attention!</b>	<p>The thru hull/seacock, strainer, valves 1 and 3, and feed pump must be deep as possible below the waterline. Strainer and feed pump as close to the through-hull fitting as possible. For trouble-free operation and to prevent air accumulation, the installation <b>must</b> be designed to incline up to the feed pump or at least horizontally.</p> <p>Experience has shown that the optimal position of the seawater inlet is around midships aft of keel. In the event of strong sea, a through-hull fitting in the bow area will interrupt the feed flow of seawater. Components behind the feed pump can be located both above or below the waterline. Here, too, a rising or horizontal installation should be provided if possible.</p> <p>Hose connections for high pressure pump can be made on the left, right or diagonally (as shown). Inlet seawater at the bottom, high pressure at the top.</p>
--	--

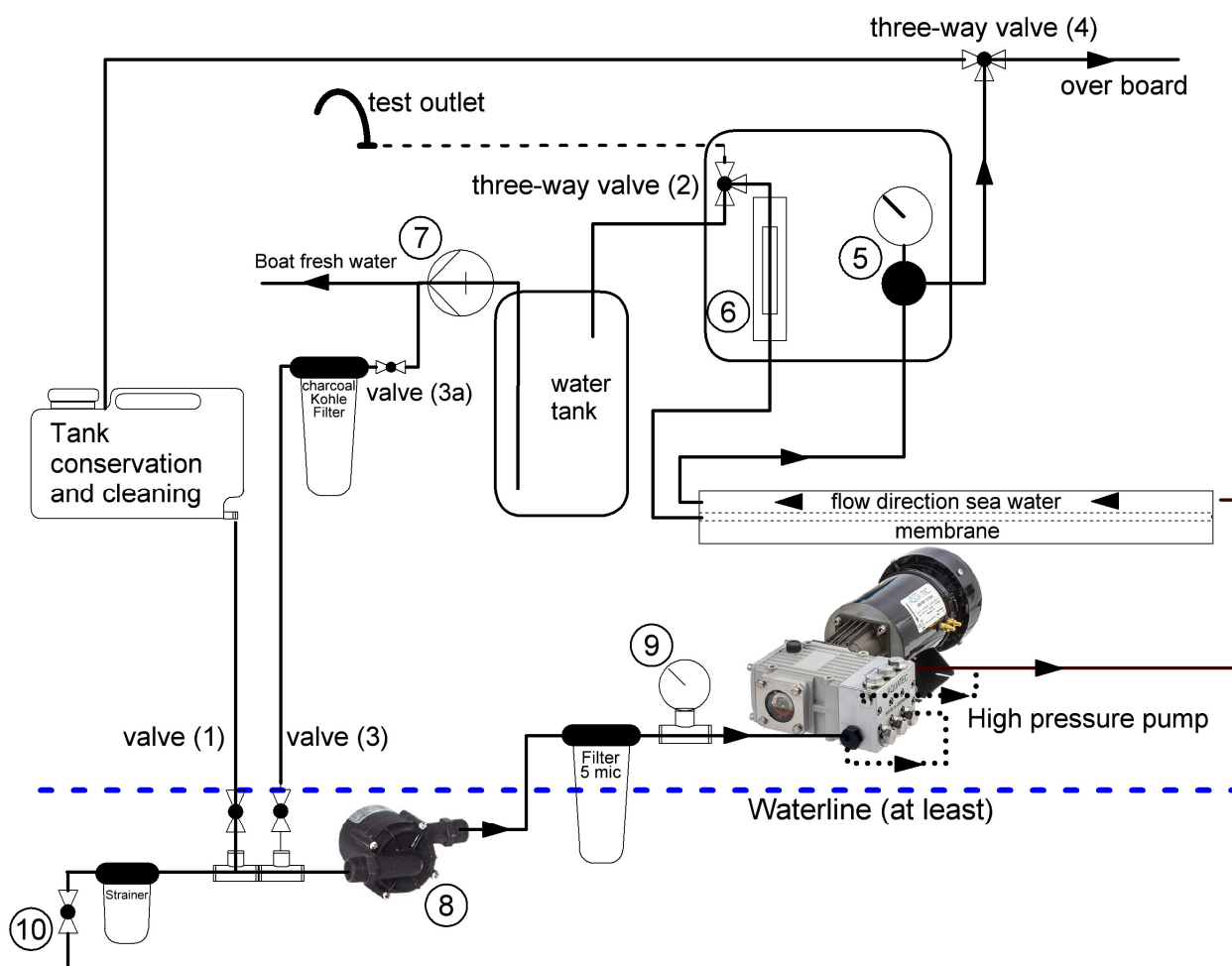
### Flow diagram



Hose dimensions (inner diameter) see specification

 <b>Hint</b>	<p>For assembly, the threads of all hose nozzles / fittings must be wrapped with a few turns of Teflon tape as strongly as possible against the screw-in direction. Very good alternative to Teflon, liquid thread sealant LOCTITE SI 5331.</p> <p>Fittings must not be screwed too tightly into the filters or taps. Do not use hemp for plastic thread.</p>
 <b>Warning!</b>	<p>Hose connections below the water line should be secured with 2 hose clamps. All hose clamps must be checked time to time and tightened if need.</p>





## Installation guide page 2

### Thru- hull fitting, Strainer and feed pump, sediment-filter.

Install a thru-hull fitting and sea-cock, deep as possible below the waterline. The best place is about mid-ships behind the keel. Strainer and feed pump as close to the through-hull fitting as possible.

In the event of swell, a through-hull fitting in the bow area will interrupt the feed flow of seawater.



 <b>Attention!</b>	<p>Avoid connecting to an existing inlet e.g. Main machine air conditioning. Common operation is usually not possible because the existing hose cross-sections prevents sufficient inflow.</p>
--	--

 <b>Attention!</b>	<p><b>Observe flow direction.</b> To avoid mechanical stress, do not mount the strainer directly to the sea-cock. The thru-hull fitting, coarse filter and the feed pump have to be located in an area that will always be under the waterline when the boat is used under normal running conditions.</p> <p>In order to avoid accumulation of air, if possible, install hoses moved upward from the thru-hull fitting to the filters and up to the high-pressure pump.</p> <p>From the sea-cock outlet to the feed pump inlet, the installation <b>must</b> be horizontal or better rising.</p> <p>In order to stay as deep as possible below the waterline, a 90 ° hose nozzle at the sea-cock outlet can be helpful.</p>
--	---



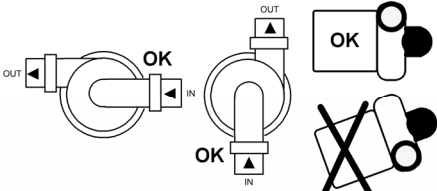

 <b>Attention!</b>	<p><b>Observe flow direction.</b> The feed pump is not self-priming and must be flooded before switching on, otherwise the bearing will be destroyed by dryness.</p> <p>To allow air to escape, switch the pump on and off several times and, if necessary, open the vent valves on the prefilter.</p> <p>If necessary, remove the high-pressure hose to the membrane at the high-pressure pump and close it again after the water has escaped while the feed pump is running. This also ensures that the HP pump is filled with water.</p> <p>The system can also be vented by flushing with fresh water.</p> <p>If necessary, refer to the further notes under Troubleshooting.</p>
--	---



<p>Mounting position of feed pump</p> 	<p style="text-align: center;"> <b>Warning!</b></p> <p>A flexible hose and the enclosed hose fittings must be used to connect the feed pump to other components (risk of breakage). Care must be taken to ensure that the installation is free of tension and vibration.</p> <p>In order to avoid damaging the feed pump during fresh water flushing via the onboard pressurized water system, observe the permissible system pressure of 2 bar maximum.</p> <p>A pressure reducer may need to be installed in front of the flushing connection.</p> <p>The following installation position must be observed in order to make it difficult to set deposits and to allow the escape of air.</p>
---	---

 <b>Warning!</b>	<p>For 24 Volt systems, the 24 V -12 V voltage transformer supplied with the feed pump must be installed. Connection feed pump: 12 volts red = positive (+), black = negative (-). Wrong polarity destroys the pump and is not covered by warranty.</p>
--	---

 <b>Attention!</b>	<p>Depending on the used thru- hull fitting, hull shape and speed, the inflow of seawater can be hampered or even be impossible. Damages to the plant due to insufficient or missing seawater inflow will not be covered by the warranty or guarantee.</p>
--	--



	<p><b>Filter housing: Observe flow direction.</b> Mount the filter housing and feed-pressure gauge as vertically as possible, head of filter-housing at the top in an easily accessible location. For a good seal of the filter housing, grease the O-rings of the filter pots with acid-free silicone grease or Vaseline. Use a PVC hose to connect the filter inlet to the outlet of the feed pump and the filter outlet with the mounted feed-pressure gauge to the high-pressure pump. The feed-pressure gauge can also be mounted anywhere between the filter housing outlet and the HP pump inlet. But do not install directly to the HP- pump. Secure all hose connections with stainless steel clamps.</p>
---	--

## Installation guide page 3

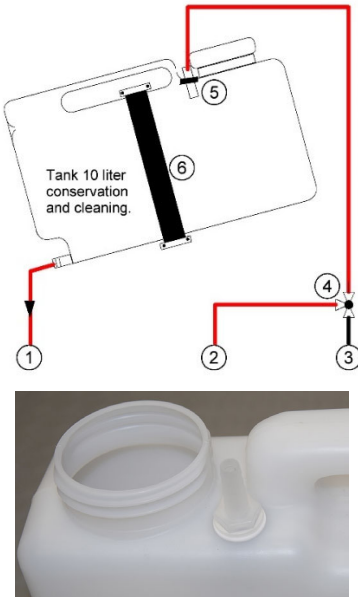
### Tank for membrane conservation and cleaning

	<p>The tank has to be mounted above the feed pump to ensure the flow to the plant. If this is not possible, an additional feed pump has to be installed.</p> <p>The tank can be fastened to any plane surface with the help of the enclosed webbing and the plastic long eyelets. If necessary, the tank can be provisionally connected and stored separately if necessary.</p> <p>For pressure equalization, you find a 2 mm hole in the center of the tank cover. sich eine Belüftungsbohrung 2 mm zum Druckausgleich.</p> <p>An oblique mounting from the tank allows complete emptying</p> <p>(1) Flow to valve no. 1 (2) coming from pressure valve (3) over board (4) Three- way- valve no. 4 (5) 13 mm hose connection. (6) Webbing tank mount.</p>
---	--

### High-pressure pump unit

 <b>Warning!</b>	 <p>Install the plant horizontally (motor feed down), stable and safe on a flat and vibration-free substrate. Experience has shown that mounting on rubber feet has little effect on sound transmission.</p> <p>Install the high-pressure pump in a dry area which allows an exchange of air necessary for cooling the motor-pump unit.</p> <p>It should be easily accessible roundly to make service and inspection work as comfortable as possible.</p>
 <b>Attention!</b>	<p>After mounting, replace the <b>yellow or red</b> plastic-screw on top of the crankcase with the <b>oil dipstick</b> with ventilation.</p> <p><b>Hint:</b> Depending on the installation situation, the hose connections of the high-pressure pump can be freely selected. Left, right or diagonal are possible. Seawater inlet at the bottom, high-pressure connection at the top. Please refer to the flow diagrams.</p>

### Membrane housing (pressure vessel)

	<p>For the installation of the membrane housings athwart ships, inclined or vertical, the housings have to be secured in the retainers so that they don't get out of place. Standard installation is horizontal, but any other angle is possible. For an inclined or vertical installation, the product water outlet and brine outlet must be at the top. For horizontal installation, the fresh water outlet can be mounted at any side of the membrane housing.</p> <p>Inserting the Aquatec pressure vessel into the mounting clamp.</p> <ol style="list-style-type: none"> <li>1) Insert pressure vessel into the clamp.</li> <li>2) Push pressure vessel firmly into the bottom of the clamp.</li> </ol>
---	---

	<p><b><u>Hose connections pressure vessel</u></b></p> <p>The pressure pipe is sealed with plastic-caps on the high-pressure connections. The product water connection is closed with a plastic plug that has to be replaced by the provided screw-in fitting for product water tube after connection of the high-pressure hoses. This prevents a drying-out of the membrane which is impregnated with preservative liquid. The plastic-caps and the plug have not to be removed until immediately before commissioning to connect the high-pressure hoses and the product water hose.</p>
---	---

## Installation guide page 4

### High- pressure hose, to be cut into two parts according to your needs.

To allow a flexible assembly, the high-pressure hose is provided as one piece of 4 meters (13.1 feet) with a V4A high-pressure fitting at both ends. Please fit the required lengths accurately before cutting the hose.



#### **Warning!**

The high-pressure hose must not be installed with a radius less than 60 mm. Avoid contact points or if necessary protect the HP hose at these points against damage and fix it flexibly.

**Note:** In case of connection problems, we optionally supply individual high-pressure hoses with pressed-on 45° or 90° connection nipples.



### Assembly instruction for the stainless high- pressure hose fittings:

- 1) Cut the hose with a clean 90 ° cut, using, for example, a hacksaw or angle grinder with a cutting disc.
- 2) Wet the inside of the hose with a lubricant e.g. Dishwashing liquid.
- 3) Screw the sleeve nut anti-clockwise onto the hose. Leave a distance of 2 mm between the hose and the inner shoulder of the sleeve nut to allow the hose to expand in length when screwing in the thread nipple.



#### **Attention!**

The hose nipple threads are treated with metal-free anti- seize paste for stainless steel on delivery. This prevents seizing of the threads when being screwed together.

- 4) Hold the sleeve nut with a wrench and screw the thread nipple with a second wrench into the hose.

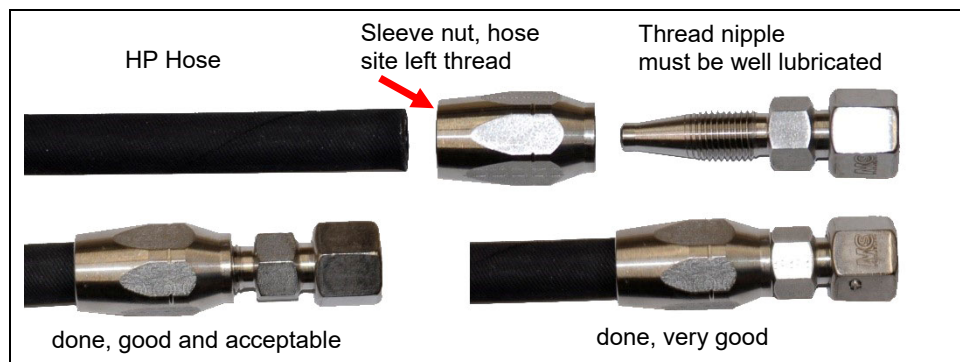

- 5) Connect the pressure connection of the high-pressure pump and the entrance of the membrane housing with a hose. The flow direction of the seawater is indicated with an arrow on the pressure housing of the membrane.
- 6) The second high-pressure hose connects the outlet of the membrane housing with the inlet at the pressure control valve on the control panel.

 <p><b>Attention!</b></p>	<p>Secure the high- pressure connection fittings in the plastic end caps of the pressure pipe against twisting with a 19 mm open-ended wrench (not necessary on end caps fittings secured with metal strips) and tighten the union nut of the high-pressure hose with a 17 mm open-ended wrench with approx. 10 Nm. Due to the O-ring sealing it is not necessary to tighten the union nut with much force.</p>
--	---

 <p><b>Attention!</b></p>	<p>Avoid over winding the body fittings in the plastic-end caps of the pressure pipe when attaching the high-pressure fittings to the membrane housing. The end caps can be damaged by over winding the fittings.</p>
--	---

**Connection hp hose and product water pipe:**

After the connection of the self-sealing high-pressure hoses, exchange the 1/4" screw plug that seals the one-sided product water connection in the end cap for the supplied fitting.

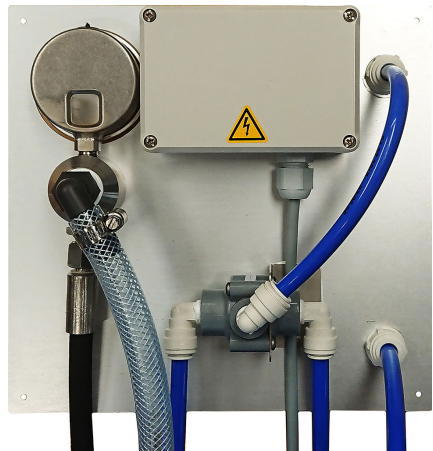
 <p>High pressure connection / Product water connection</p>	<p><b>Note:</b> The high-pressure fittings and high-pressure hose connections are self-sealing by pre-assembled O-rings.</p> <p><b>Attention:</b> Only use cylindrical tread fittings (1/4" BSP) in the plastic-end caps of the pressure vessel. Taper threads may cause cracks.</p>	 <p>(1) (2) (3) (4) (5)</p>
---	--	--



**Hose connections on the control panel**

- (1) 1/4" High-pressure hose, concentrate coming from outlet pressure pipe.
- (2) 1/2" 13 mm PVC hose, concentrate (brine), overboard.
- (3) Product water to freshwater tank.
- (4) Product water to test-outlet.
- (5) Product water, coming from freshwater-outlet pressure pipe

**Control panel.**

Mount the control panel as vertically as possible, pressure gauge on top. Optimal accessibility from the rear for connection and regular control of the hose connections.

The control panel can be installed into a wall, or it can be mounted in front of a wall or vertically free-standing by using the brackets to be provided on board.

	<p><b>Fresh water flushing system</b></p> <p><b>Observe flow direction.</b> Mount the filter housing for the charcoal filter as vertically as possible in an easily accessible location between your fresh water pressure system and the valve (3). Install the hose connections according to the flow diagram. Valve (3a) at the filter inlet is only used for closing during the filter change. Depending on the conditions on board valve (3a) may make valve (3) no longer necessary.</p> <p> <b>Warning!</b> In order to avoid damaging the feed pump during fresh water flushing via the onboard pressurized water system, observe the permissible system pressure of 2 bar maximum. A pressure reducer may need to be installed in front of the flushing connection.</p>
---	--

## Installation guide page 6

### Connection concentrate (Brine):

Connect the outlet on the pressure control valve in the control panel to an on-board outlet through a hose 1/2" = 13 mm inner diameter.



#### **Warning!**

This on-board outlet must be above the waterline and must not be lockable. The material for the thru-hull must not be made of acetal.

### Fresh water pipe

Direct the PE- fresh water pipe from the fresh water outlet at the membrane housing to the inlet at the flow meter in the control panel.

From the three-way valve (no. 2), direct one pipe to the test-outlet and one pipe from the outlet to the fresh water tank.



#### **Warning!**

Never block the product water line (valve etc.). This damages the membrane and leads to bursting of the product water line.

#### EASY TO MAKE A CONNECTION

Cut the tube square and remove burrs and sharp edges.  
Ensure the outside diameter is free of score marks.  
Push the tube 20 mm into the fitting, up to the tube stop.



To disconnect, ensure the system is depressurized, push the collet square against the fitting. With the collet held in this position the tube can be removed.



#### **Attention!**

In order to avoid unnecessary back pressure in the product water line, only use the blue 3/8" product water pipe up to a length of approx. 6 m. If necessary, use the supplied adapters from the PE pipe to a 13 mm PVC hose.

### Advice:

A good place for the test-outlet is the sink or basin, where it can be installed by an additional water outlet **without** cut off cock.

At this position, an easy control of the product water is possible, furthermore you can bottle your drinking water here directly. This ensures that the quality of the drinking water will be best, since it does not have to follow a detour over the drinking water tank on-board.



#### **Attention!**

If the product water inlet is installed below the tank waterline chlorinated water (that possibly entered the tank at the last shore water fill up) might flow back from the tanks into the membranes. As chlorine destroys the R.O. membranes, a return flow from the tank has to be avoided. A return from the water tank is not possible if the 3-way valve no. 2 in the control panel is switched to the test outlet position. A non-return valve must not be used.



## Electrical connection

<b>Warning!</b>	<b>Danger for life!</b> It is obligatory that an electrician has to make the connection. Incorrect connection is dangerous to life.
-----------------	---

<b>Warning!</b>	<b>Danger for life!</b> For the connection of the cables, suitable press cable lugs and the correct pressing tool must be used.
-----------------	---

<b>Warning!</b>	<b>Danger for life!</b> For all work on electrical components, the entire system must be switched off and a message must be left on the shutdown device.
-----------------	--

<b>Note:</b> As the output power of the plant depends on the tension of the driving motor, in the calculation of the wire cross sections a voltage drops of maximum 4% should be estimated to provide for the maximum continuous output. The required cross section in mm <sup>2</sup> refers to the cable total length which results from the addition of the plus and minus cable lengths.	Total length	12V / 24V
	5 metres	10 / 6 mm <sup>2</sup> (AWG 7 / 9)
	10 metres	16 / 10 mm <sup>2</sup> (AWG 5 / 9)
	15 metres	25 / 16 mm <sup>2</sup> (AWG 3 / 5)
	20 metres	35 / 16 mm <sup>2</sup> (AWG 2 / 5)
	25 metres	50 / 25 mm <sup>2</sup> (AWG 1 / 3)

### Electrical connection for 12- volt systems

	<ol style="list-style-type: none"> <li>1 - Battery</li> <li>2 - Fuse for high-pressure pump (DD 500 = 12 V: 60 A)</li> <li>3 - Car fuse for control and feed pump 10 A</li> <li>4 - Aquatec operator panel</li> <li>5 - Switch feed pump</li> <li>6 - Switch relay high-pressure pump</li> <li>7 - High current relay</li> <li>8 - High pressure pump, connection red= positive +, pump turns clockwise.</li> <li>9 - Feed pump</li> </ol> <p>Supply line for the switches feed pump and relay control 1,5 to 2,5 mm<sup>2</sup> Connecting cables are not included in scope of delivery. Switches in the control panel, high current relay, fuse holder and fuses are included.</p>
--	--

### Electrical connection for 24- volt systems

<b>Warning!</b>	<b>Install the supplied 24VDC to 12 VDC converter for 12-volt DC feed pump</b>
-----------------	--

	<ol style="list-style-type: none"> <li>1 - Battery</li> <li>2 - Fuse for high-pressure pump (DD 500 = 24 V: 40 A)</li> <li>3 - Car fuse for control and feed pump 10 A</li> <li>4 - Aquatec operator panel</li> <li>5 - Switch feed pump</li> <li>6 - Switch relay high-pressure pump</li> <li>7 - High current relay</li> <li>8 - High pressure pump, connection red= positive +, pump turns clockwise.</li> <li>9 - Feed pump 12 volt</li> <li>10- 24 VDC to 12 VDC converter for feed pump</li> </ol> <p>Supply line for the switches feed pump and relay control 1,5 mm<sup>2</sup> Connecting cables are not included in scope of delivery. Switches in the control panel, high current relay, fuse holder and fuses are included.</p>
--	---





**Blank page**

## Inspection – maintenance – oil change

 <p><b>Attention!</b></p>	<p><b>Important:</b> Check the oil level and condition of the high-pressure pump oil daily. In the event of condensation in the oil (whitish/ greyish discoloration due to continuous operation, warm environment), change the oil immediately.</p>
--	---

 <p><b>Attention!</b></p>	<p>Regularly check hose connections and HP pump for leaks. During operation, check the entire system for possible leaks and smooth running. Operation is not permitted if the system is faulty.</p>
--	---

### High-pressure-pump

<p>First oil change after 50 hrs., any condensed water, change the oil immediately, then every 200 hrs or after 6 months at the latest. <b>Oil type:</b> Gear oil ISO VG 220, alternatively automotive gear oil SAE 90 GL4.</p>		
<p style="text-align: center;"><u>Oil change instruction</u></p> <p>The oil can be drained via the drain plug at the rear of the crankcase. The drain plug (wrench size 19 mm) or Hexagon socket 8 mm under the crankcase. Sealed of copper ring.</p> <p>Alternatively, the oil can be extracted through the oil dipstick opening using a suction pump.</p>		<p>Dipstick full screwed into crankcase</p> <p style="text-align: center;">Oil level Slightly below center sight glass <b>Quantity 0,24 Liter</b></p>
		

### Filter

Filter	Maintenance	Time interval
Coarse filter	Cleaning	as required
Prefilter	Replace filter elements	as required, or pre-pressure seawater below 0.2 bar
Charcoal filter	Replace filter element	every 3 months

## Replacement of membrane

 <p><b>Warning!</b></p>	<p>The membrane is preserved with a chemical. During unpacking and inserting, please wear protective gloves for your own safety. On contact with the preservative liquid, the affected skin areas have to be rinsed thoroughly with water.</p>
--	--

 <p><b>Attention!</b></p>	<p>To avoid that the new membrane dries out, it may only be removed from the plastic packaging just before commissioning the plant. The <b>manufacturer's label</b> on the membrane <b>must not be removed</b>.</p>
--	---

	<p>Before installing a new membrane, the accompanying rubber V-cup seal must be mounted on the side of the planned sea water entry. (Depending on the manufacturer, the ring could already be mounted.) In doing so, the open side of the V-ring must point toward the sea water entry side.</p> <p>For easy installation, all sealing rings and membrane connectors should be greased with a light coating of glycerine or Vaseline.</p>
---	---

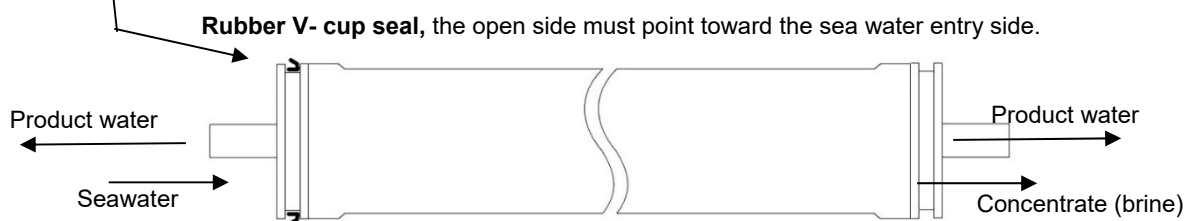

 <p><b>Note!</b></p>	<p>The product water connection can be located on any side of the pressure tube and is independent of the flow direction seawater.</p>
--	--

### Demounting the membrane:

For demounting the membranes, screw off the screws M6x20 at both ends of the AQUATEC pressure vessel. (Screw tightening torque for the holding clips 3 Nm). Then take off the stainless-steel holding clamps. Push the end caps in a little before pulling them out to loosen the possibly stuck O-rings. Thereafter, pull the end caps out of the pressure pipe with a slight pull at the stainless steel-fittings of the pressure hoses and slightly sidewise movements.

- 1) O-ring
- 2) O-ring
- 3) End cap
- 4) Pressure ring
- 5) Retaining clip, A 1x
- 6) Retaining clip, B 2x
- 7) Product water
- 8) High pressure fitting
- 9) Secure clip
- 10) Screws M6 2x

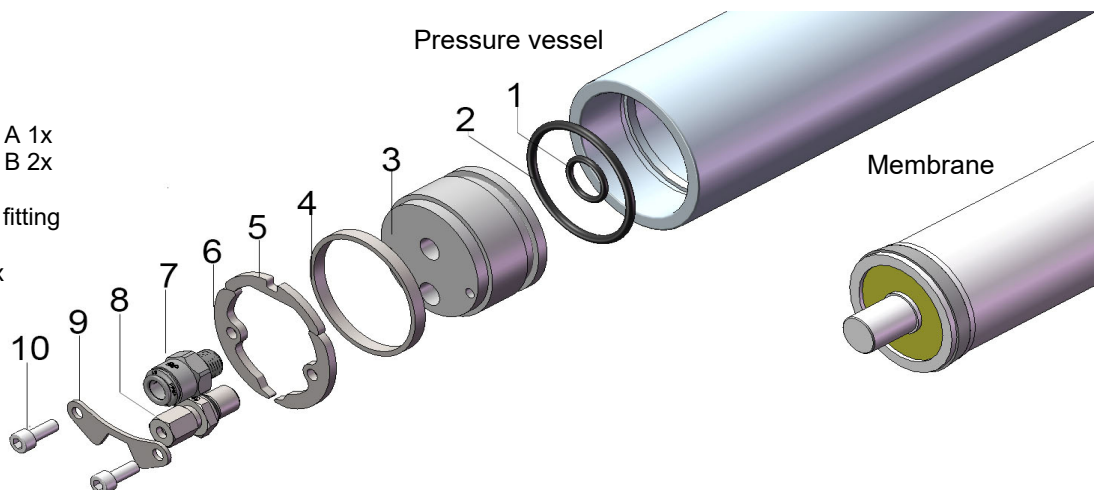

The membrane has to be shoved out of the pressure pipe in flow direction of sea water, because the dihedral rubber V-ring of the membrane prevents lateral movements against the flow direction.

According to this, during assembly, the membrane has to be shoved into the pressure pipe in flow direction. When mounted, necessarily watch the O-rings to avoid damage. Before installation of the membranes, first fit the end cap on the side of the concentrate in order to thereupon shove the membrane against this cap.

## Troubleshooting

 <b>Warning!</b>	<b>Noisy operation, vibrations, unsteady pressure.</b> Prolonged operation with the above error leads to failure of other components.
---	--

<b>Noisy running, pulsating, unsteady and possibly low working pressure, banging or strongly vibrating of high-pressure hose.</b>
---

Air in system	To bleed air from the system a fresh water flush via the on-board pressurized water system is often optimal for removing existing air from the system.
---------------	--

**Check of sea water supply and venting:**

Remove the high-pressure hose at high-pressure-pump that is connected to the membrane. Switch on the feed pump. Water should now come out with some pressure at the outlet of the HP pump.  
To collect the discharged water, put a ½" PVC hose over the thread of the high-pressure hose connection fitting.  
If OK, reconnect the HP-hose and switch on the FP-pump and HP-pump for further venting of the system and start plant up normally.

If no water flows out, remove the inlet hose from the HP pump for cross-checking. If water flows out at a rate of approx. 6-12 litres/minute when the FP pump is switched on, the feed is OK. The fault is caused by sticky valves inside the HP pump (possibly due to the system shut down for a longer period of time).

If no water escapes, the sea water inlet is blocked, or the feed pump may be defective.

Feed pump defective	Replace or clean feed pump
Intake clogged	Clean intake
Prefilter, strainer dirty	Clean or replace filter

**Dirty or defective valve of high-pressure pump.**

Before removing the valves, it sometimes helps to run the system for a few minutes at low pressure to remove the dirt. Which of the 6 valves causes a problem cannot be seen from the outside. The upper 3 pressure valves rarely cause problems. As a rule, it affects one of the 3 lower intake valves. To rectify the fault, unscrew the valve caps (hexagonal screws, width across flats 22 mm or 19 mm) and pull out the valves with needle-nose pliers. Since even the smallest barely visible contamination creates the problem, often no contamination can be detected. Often disassembling, checking and reassembling the valve is sufficient to correct the fault. A longer standstill time can also lead to a disturbed seawater supply by sticking of the valve plate with the valve seat (usually it concerns the lower intake valves).

Refer to the parts diagrams on the following pages.

Very rarely, a dirty pressure control valve can also prevent pressure buildup. However, fluctuating working pressure or irregular running is not a problem of the pressure control valve.

 <b>Note!</b>	Grease the thread of the valve screws with metal-free anti seize paste for stainless to prevent seizure.
--	--

<b>Motor does not turn or turns too slowly.</b>
---

Less or no voltage, relay defective Fuse defective Carbon brushes jammed in holder.  Carbon brushes consumed approx. 3,000 hrs.	Check voltage at motor connection, replace relay. Replace fuse. Disassembling the motor and making the carbon brushes operable Disassemble motor and replace carbon brushes.
---	---

<b>Motor makes grinding noises</b>
------------------------------------

Motor magnets detached due to overheating	Disassemble motor and reattach magnets with epoxy adhesive.
---	---

<b>Oil eakage between pump head and crankcase.</b>
--

Crankcase gasket rings defective	Replace gasket rings
----------------------------------	----------------------

<b>Water leakage between pump head and crankcase.</b>
---

Plunger(s) defective / o-rings plunger defective HP / LP seals defective	Replace plunger(s)/ replace o-rings. Replace seals.
---	--

<b>Water in the crankcase (whitish or grayish discolored oil)</b>
---

High humidity (mostly), wrong oil.	Reduce oil change interval, use right oil.
------------------------------------	--

## Troubleshooting

### Product water quantity

 <p><b>Note!</b></p>	<p>The drinking water production changes according to the salinity, the temperature of the seawater and the age of the R.O. membrane. The data regarding the fresh water production apply to a salinity of 35 grams/ litre at a temperature of 25° Celsius (77° Fahrenheit) at the new membrane.</p> <p>A discrepancy up to +/- 10% also in the power consumption, especially in the first 50 hours of operation, are usual.</p> <p>At a sea water temperature below 25°C the product water quantity will be reduced as follows: e.g. water temperature 15°C, approx. minus 20% / water temperature 5° C, approx. minus 35%.</p>
---	--

#### Product water quantity too low:

<p>Membrane is blocked or defect. Temperature seawater lower than 25 ° Celsius. Salinity seawater higher than 35,000 ppm. Reduced sea water flow because of blocked or dirty filters. Insufficient fresh water rinsing after every use. Insufficient chlorine separation by the charcoal filter, assuming chlorine is or was present in the rinsing tank, chemicals or oil sucked in. HP pump: dirty or defective valve. HP pumps insufficient performance.</p>	
Less voltage.	<p>Check voltage at connections motor of high-pressure pump, relay, fuses and all cable connections up to battery.</p> <p>Voltage at hp-motor under a working pressure of 55 bar should be 12.5V or 25V. Lower voltage leads to a lower speed associated with lower pump performance.</p>
Current consumption according to specification too low? DD 500 12V = about.44 Ampere DD 500 24V = about.22 Ampere	<p>Voltage low at hp-motor. Voltage OK? Probably dirty or defective valve. Carbon brushes (4 pieces) Motor HP pump stuck or faulty contact or used up. Please refer to the previous page. (Motor does not turn or turns too slowly).</p>
<b>Product water not smell-free after approx. 5 minutes.</b>	
1) Sediment-filter dirty. 2) and or Membrane dirty.	1) Replace filter. 2) Clean membrane, use cleaner no. 1
<b>Salty taste of product water</b>	
Membrane defect.	<p>Replace membrane. <b>Note:</b> Chemical cleaning has no effect here.</p>

#### Control of HP pump's performance.

<p>Current consumption consistent with specification OK? Recommendation: accurate test of the HP pump output:</p> <p>Instruction for testing the flow (litre/ minute) of the HP pump.</p> <ol style="list-style-type: none"> <li>1) Place the plant into operation.</li> <li>2) Adjust the working pressure.</li> <li>3) Turn the 3-way valve No: 4 to operate toward the 5 or 10-liter conservation tank.</li> <li>4) Alternatively, pipe seawater concentrates into a bucket to measure the quantity.</li> <li>5) Using a stop-watch, to measure the time until filling. In order to avoid an overflow, strictly reposition the valve to the board setting shortly before the tank is full.</li> <li>6) In addition, collect the amount of product water in the same period of time over the test outlet in a vessel and add it.</li> </ol> <p>HP pump performance in liters per minute at 55 bar working pressure: DD 500, 3-3.3 litre/ minute</p>
---

## Tightening torques and spare-part-numbers of high-pressure-pump

 <p><b>Note!</b></p>	<p><b>When ordering spare parts please state Pump-Head Serial No.</b></p>
---	---

Serial-number

Screw No. 16C  
secure with Loctite 243  
Tightening torque 22,5 Nm

Washer 16D  
on both sides  
seal with Loctite 577.

Tightening torque / mounting:

Screws No. 3/5/6/10 – Torque 10 Nm  
Valve screws No. 32 - Torque 25 Nm  
Head-Screws No. 34 - Torque 12 Nm  
Perform the tightening sequence (1-8)  
2 times.

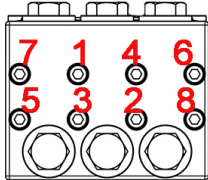

Before mounting the pump-head,  
slide items 20 to 24 onto the plungers.  
Insert item 25 into the pump head.

 <p><b>Note!</b></p>	<p>Grease the thread of the valve screws (No. 32) with e.g. Anti-Size (metal-free for stainless steel) to prevent seizing.</p>
---	--



### Spare part numbers high pressure pump

 <b>Note!</b>	<b>When ordering spare parts please state Pump-Head Serial No.</b>
--	--

No.	Order No.	Description	Qty
1	141609	Crankcase	1
2	141610	Oil Dipstick	1
3	141611	Crankcase Cover	1
3A	141612	Oil Drain Plug Assy	1
4	141613	O-Ring	1
5	141614	Plug Assy	1
6	141615	Cylinder Screw M6 x 16	4
6A	141616	Spring Washer 6,3	8
7	141617	Bearing Cover	1
8	141618	Oil Sight Glas	1
9	141619	O-Ring	1
10	141620	Hexagon Screw M6 x 12	4
11	141621	Radial Shaft Seal	1
12A	141622	Ball Bearing	1
12B	141623	Ball Bearing	1
13	141624	Crankshaft DD500 12/ 24 V- AC 55, 230/1/50	1
13	141625	Crankshaft AC 65/ 110, 230/1/50	1
13	141626	Crankshaft AC 75/ 135, 230/1/50 (AC 150, 115/1/60 und 440/3/60)	1
13	141627	Crankshaft AC 150, 400/3/50	1
13	141628	Crankshaft AC 150- 240, 230/1/50 (AC 190/ 240, 400/3/50)	1
14	141629	Fitting Key	1
15	141630	Connecting Rod	3
16	141631	Plunger Assy 18mm dia.	3
16A	141632	Plunger	3
16B	141633	Plunger Pipe	3
16C	141634	Tension Screw (secure with Loctite 243 torque 22,5 Nm)	3
16D	141635	Steel Ring (seal on both sides with Loctite 577)	3
16E	141636	O-Ring	3
16F	141637	Support Ring	3
17	141638	Crosshead Pin	3
19	141639	Gear Seal	3
20	141605	Sealing girder	3
21	141640	O-Ring	3
23	141602	LRF- Ring	3
23A	141641	Low pressure seal black	6
23B	141654	Support Ring LP	3
24	141644	Support Ring HP	3
25	141642	High pressure seal brown	3
26	141600	High pressure head	1
26A	141648	Valve assy (27-30)	6
27	141604	Valve Seat	6
28	141603	Valve Plate	6
29	141606	Valve Spring	6
30	141607	Spring Tension Cap	6
31	141608	O-Ring	6
32	141601	Plug	6
33	141649	O-Ring -S210062	6
33	141493	O-Ring S210063-	6
34	141645	Hexagon Screw M6 x 55	8
38	141646	Plug G1/4"	1
39	141563	Plug G1/2"	1

### Pressure regulation valve

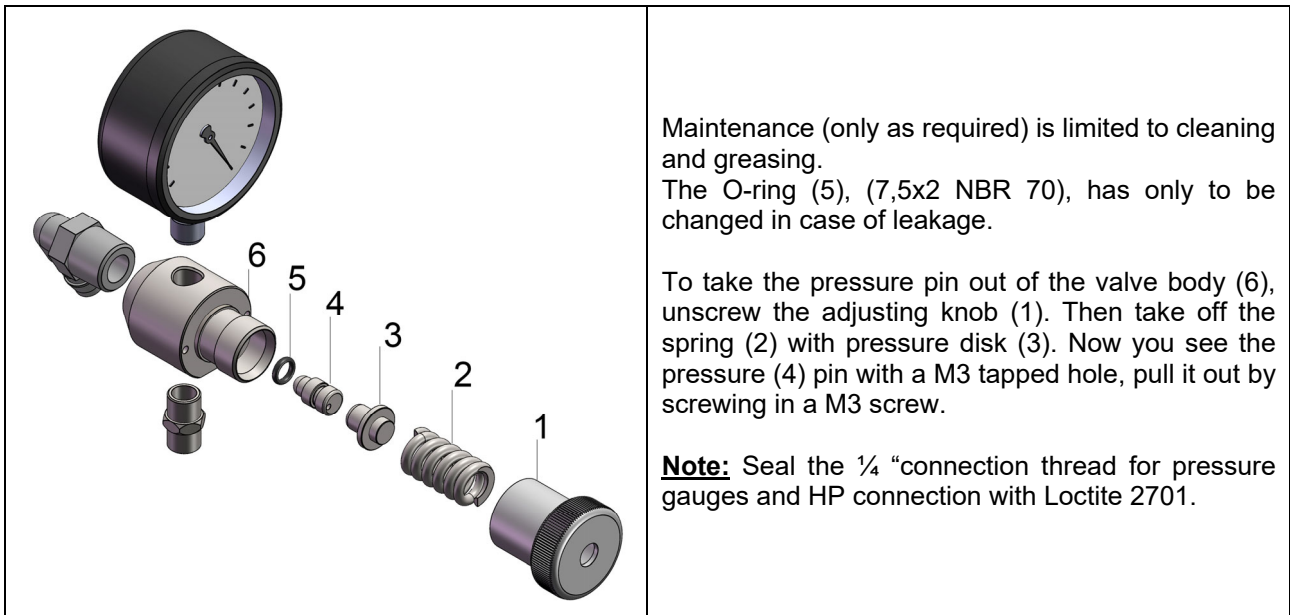

### Exploring Diagram Clutch HP- pump / motor

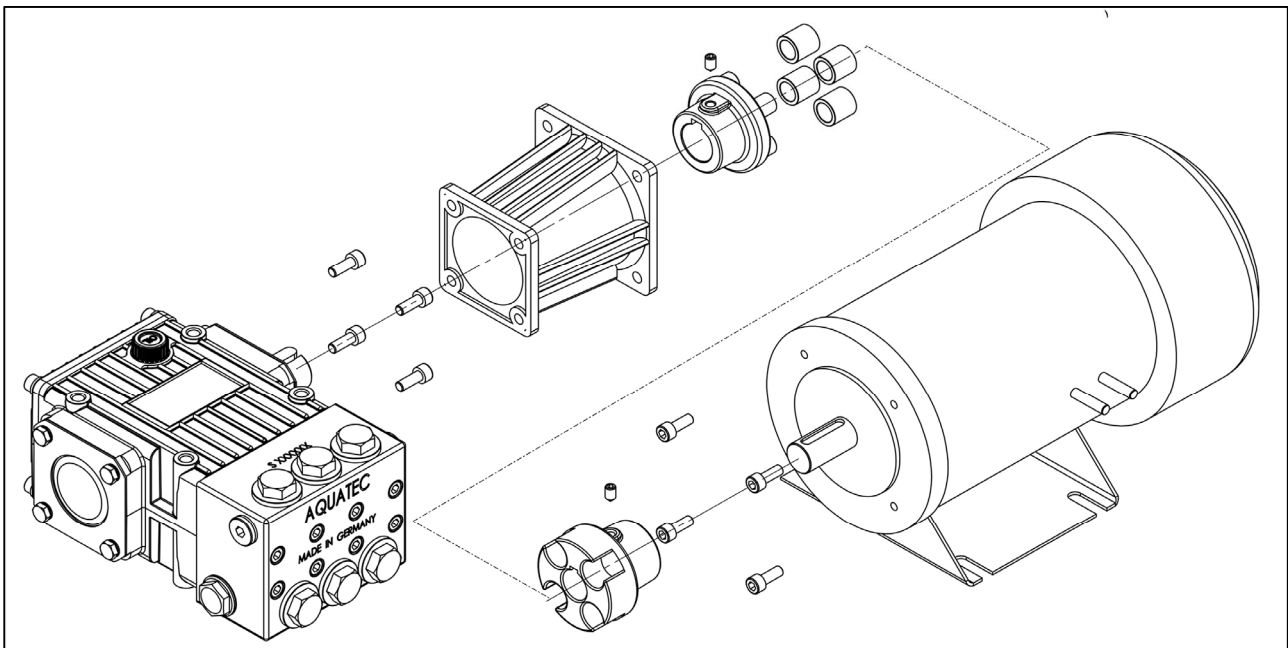

To remove the high-pressure pump from the motor, first remove the 4 screws of the clutch housing on the motor. Remove the high-pressure pump with the coupling housing.  
Then unscrew the grub screw on the pump side of the coupling half and remove the coupling half. Finally, unscrew the 4 screws of the coupling housing on the pumps and remove the coupling housing from the pump.

## Specification / Dimensions

### Hose dimensions inner diameter

 <b>Warning!</b>	Aquatec Watermaker are designed for permanent installation on ships. Operation of the system is only permitted with clean seawater.
---	---

Specification – AQUATEC Watermaker	DD 500
<b>Hose dimensions (inner diameter)</b>	
Diameter thru-hull fitting	3/4", 19 mm recommended
Thru-hull fitting up to high pressure pump	1/2" / 13 mm
Outlet over board: concentrate (Brine)	1/2" / 13 mm
Fresh water flush, inlet pressure should not exceed 2 bar.	1/2" / 13 mm
conservation/ cleaning	1/2" / 13 mm
Pipe product water up to control panel	3/8" PE pipe
Hose product water to fresh water tank	1/2" / 13 mm
High pressure hose	1/4"
<b>Technical datas</b>	
Membrane typ	Seawater SW 2540
Working pressure	55 - 60 bar, maximum 60 bar
Salt reduction	Up to 99,5%
PH range	2 – 11
Chlorine tolerance	Less than 0,1 ppm
Seawater temperature	+ 4° bis 38° Celsius
Water production, 3,5% salinity, 25°C und 55 bar (800-870 psi) working pressure	55 l/h +/- 15%
Power requirement HP pump (+/- 10%)	12.5VDC – 40A / 25VDC – 20A
Power requirement feed pump	12.5VDC – 1.0A / 25VDC – 0,5A
Operating time	continuous duty up to 30°C ambient temperature

#### Filter

Sediment filter 5 micron	Cartridge 9 7/8"x 2,5"(251 mm x 65 mm)
Charcoal filter for fresh water flush	Cartridge 9 7/8"x 2,5"(251 mm x 65 mm)

## Dimension

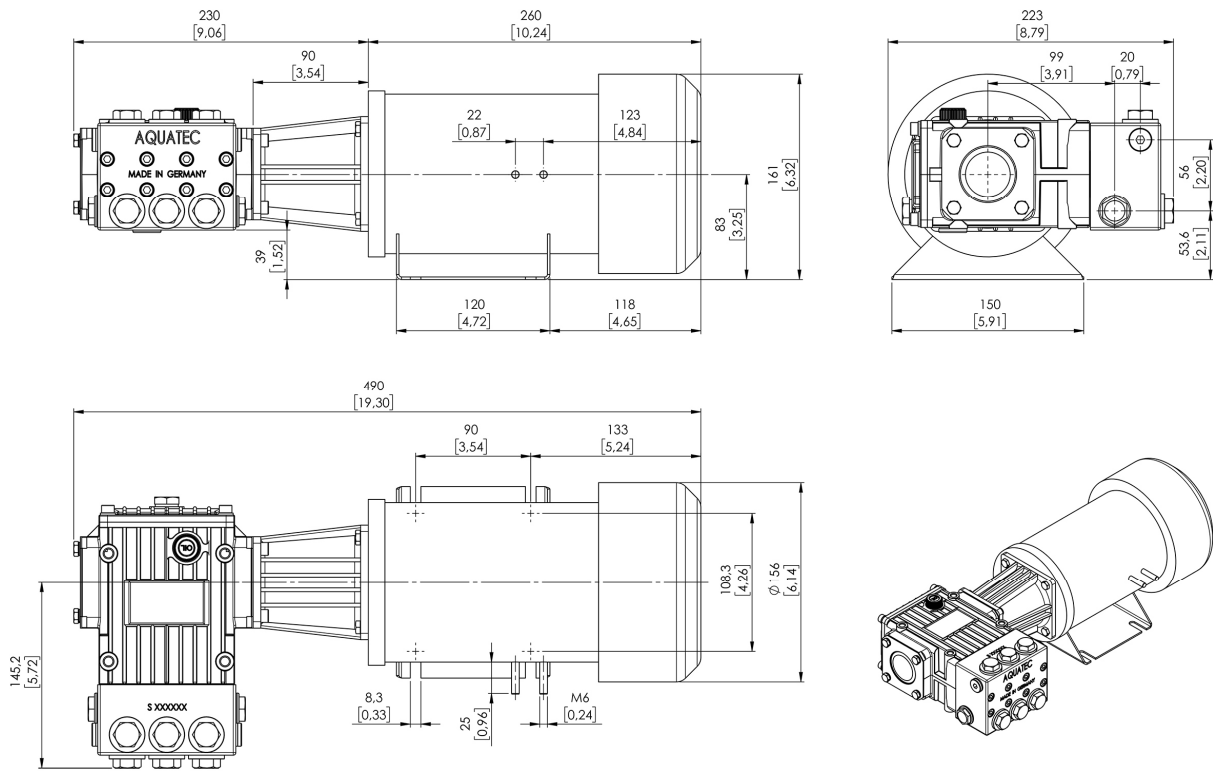

**Motor pump unit DD 500**

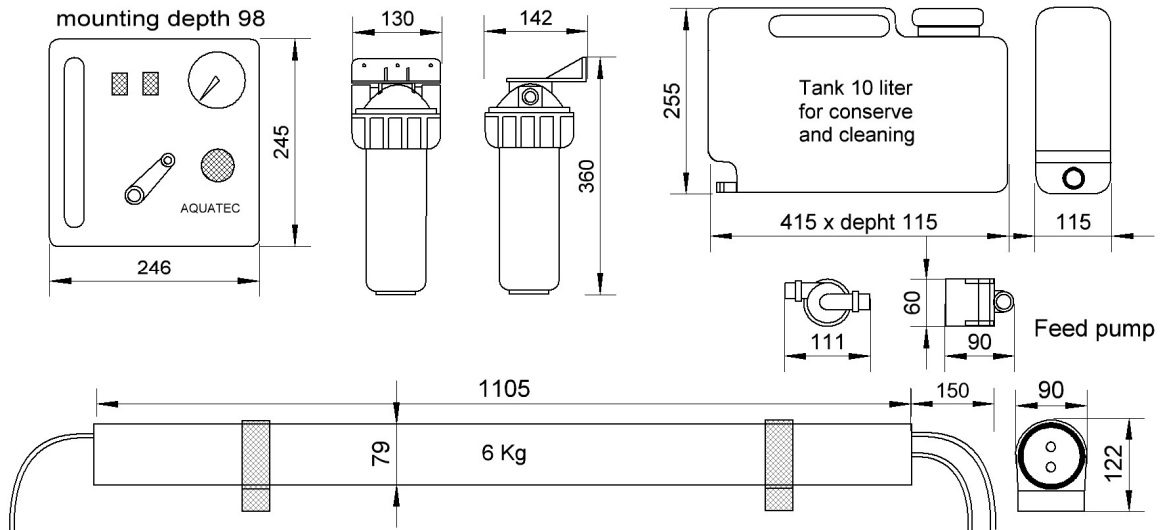

## Partlist AQUATEC Watermaker DD 500

		12 Volt	24 Volt
No.	Description	Quantity	
<b>Motor Pump Unit</b>			
141680	12V Motor Pump Unit	1	
141681	24V Motor Pump Unit		1
130150	Hose Tail 3 part 1/2" x 13 mm	1	1
<b>Feed Pump</b>			
142090	Feed Pump 1/2" 12 Volt	1	1
130150	Hose Tail 3 part 1/2", 13mm	2	2
122999	24VDC to 12VDC converter f. Feed Pump		1
<b>Control Panel</b>			
122020	Control Panel cpl. mounted	1	1
131182	Straight Adaptor 1/2" x 3/8" Tube	2	2
130150	Hose Tail 3 part 1/2" x 13 mm	2	2
131184	Equal Elbow 3/8" Tube	1	1
<b>Feed Pressure Gauge</b>			
128011	Feed Pressure Gauge	1	1
134153	Tee 1/2" x 1/2" x 1/2"	1	1
134158	Hexagon Reducing Bush 1/2" x 1/4"	1	1
130140	Hexagon Nipple 1/2" PP	1	1
130110	Hose Barb 1/2" x 13 mm PA	2	2
<b>Manifold Feedflow</b>			
129126	Ball Valve 1/2"	2	2
134153	Tee 1/2" x 1/2" x 1/2"	2	2
130140	Hexagon Nipple 1/2" PP	3	3
130110	Hose Barb 1/2" x 13 mm PA Norma	4	4
<b>Div.</b>			
135030	Hose-Clips Stainless 1/2"	27	27
133122	HP Screw. Fitting, stainless, 133119/ 133121	2	2
135012	High Pressure Hose 4,0 m, 1x 90°, 1x straight	1	1
135020	PVC Hose 13 mm	6	6
131103	PE Pipe 3/8"	6	6
120090	User Manual	1	1
125105	Preservation Chemical No. 3, 300 g	1	1
<b>E- Parts</b>			
123080	High Current Relay 12 Volt	1	
123081	High Current Relay 24 Volt		1
123190	High Current Fuse Holder	1	
123185	Fuse 60 A	1	
123184	Fuse 40 A		1
123178	Inline Fuse Holder	1	1
123200	Fuse 10 A	1	1

		12 Volt	24 Volt
No.	Description	Quantity	
<b>Tank</b>			
128002	Tank 10 Liters	1	1
130091	Tank Connection 1/2" x 13 mm	1	1
130150	Hose Tail 3 part 1/2" x 13 mm	1	1
130136	Hose Barb 3/4" x 13 mm PP	1	1
128005	Tightening Strap	1	1
128006	Bracket Tightening Strap	2	2
128009	Teflon Tape	1	1
<b>Sediment Prefilter</b>			
130140	Hexagon Nipple 1/2"	1	1
130110	Hose Barb 1/2" x 13 mm PA	4	4
130116	Hose Barb 90° 1/2" x 13 mm PA	3	3
130172	Elbow 1/2" male/female	1	1
129181	Mini Ball Valve 1/2" male/female	1	1
125129	Filter Housing 1/2"	2	2
125132	Bracket Filter Housing	2	2
125134	Screws f. bracket housing filter	8	8
125131	Wrench Filter Housing	1	1
125120	Sediment Filter 5 mic.	1	1
125122	Carbon Filter	1	1
<b>Strainer</b>			
125092	Coarse Filter 3/4"	1	1
139153	Bracket Coarse Filter	1	1
130136	Hose Barb BSP 3/4" x 13 mm PP	3	3
<b>Manifold Concentrate/ Circulation</b>			
129111	3 Way Valve 1/2" PVC	1	1
130110	Hose Barb 1/2" x 13 mm Norma	3	3
<b>Pressure Vessel</b>			
138998	Clamps Pressure Vessel	2	2
139800	Pressure Vessel with membrane	1	1
131181	Straight Adaptor 1/4" x 3/8" Tube	1	1
<b>Options (Cruising Kit)</b>			
141652	Kit Valves: 6 Pieces	1	1
141651	Kit HP/ LP Gasket set	1	1
139987	Kit O-rings 1 Pressure Vessel	1	1
125120	Sediment Filter 5 mic	4	4
125122	Carbon Filter	2	2
125101	Cleaning Chemical No.1, 400 g	1	1
125104	Cleaning Chemical No.2, 500 g	1	1
125106	Preservation Chemical No.3, 600 g	1	1